

GPS+LTE+WIFI Combination Antenna JCE305

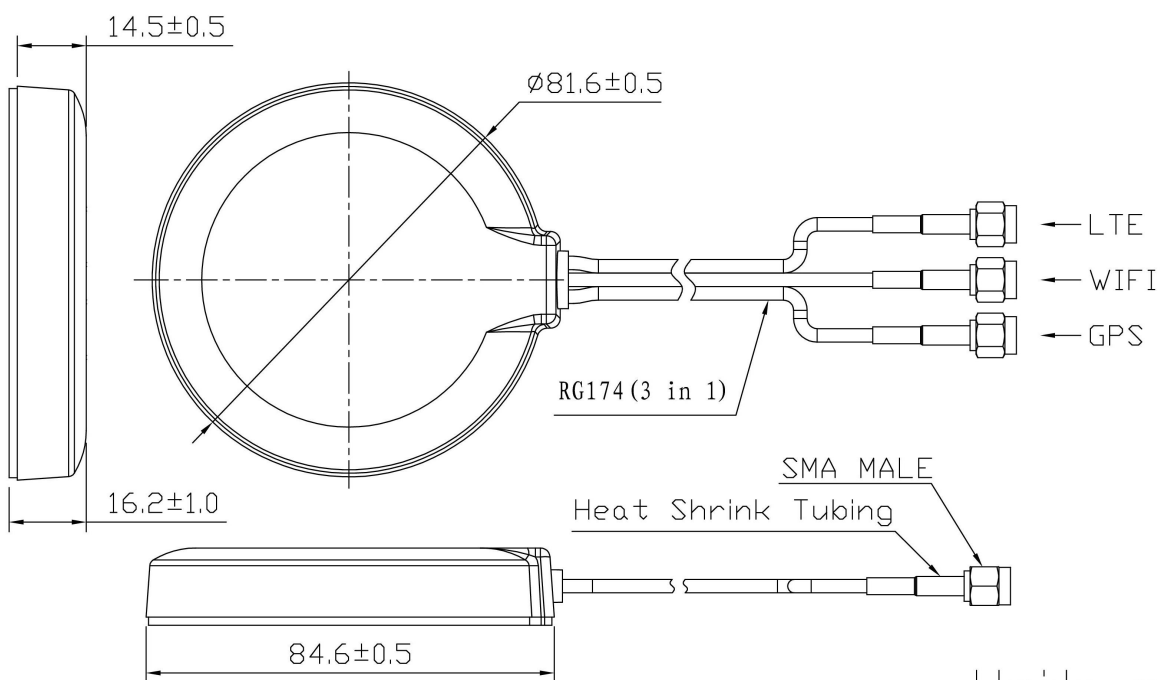

DIMENSIONS



Unit: mm

JIAXING JINCHANG ELECTRONIC TECHNOLOGY CO.,LTD

Add: 398#, Zhenye Road, South Street, Jiaxing, Zhejiang, China

Http:// www.jinchanggps.comE-mail: jcgps@vip.163.com

Tel: 86-0573-83692157/83692605/83958637 Fax: 86-0573-83958635

SPECIFICATIONS

Item		Specifications	
GPS Antenna	Dielectric Antenna	Center Frequency	1575.42±3MHz
		Band Width	CF±5MHz
		Polarization	RHCP
		Gain	2dBic (Zenith)
		V.S.W.R	<1.5
		Impedance	50Ω
		Axial Ratio	3dB (max)
	LNA	Gain	28±2dB
		Noise Figure	<1.5dB
		V.S.W.R	<2.0
Supply Voltage		2.2~5V DC	
Current Consumption		5~15mA	
LTE Antenna		Frequency Range	698~960MHz/1710~2700MHz
		V.S.W.R	<3.0
		Polarization	Linear
		Gain	2.0dBi
		Impedance	50Ω
WIFI Antenna		Frequency Range	2400~2483.5MHz
		Polarization	Linear
		Gain	3dBi
		V.S.W.R	<2.0
		Impedance	50Ω
Mechanical		Cable	RG174
		Connector	SMA/FAKRA or others
		Material	ABS
		Mounting Method	Adhesive/Magnet
Environmental		Operating Temperature	-40℃~+85℃
		Relative Humidity	Up to 95%
		Ingress Protection	IP67

	Vibration	10 to 55Hz with 1.5mm amplitude 2hours
	Environmentally Friendly	ROHS Compliant

Radiation Pattern

GPS Antenna

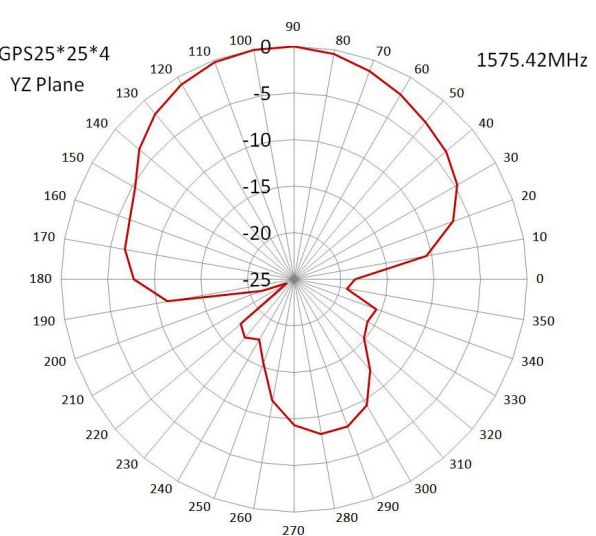
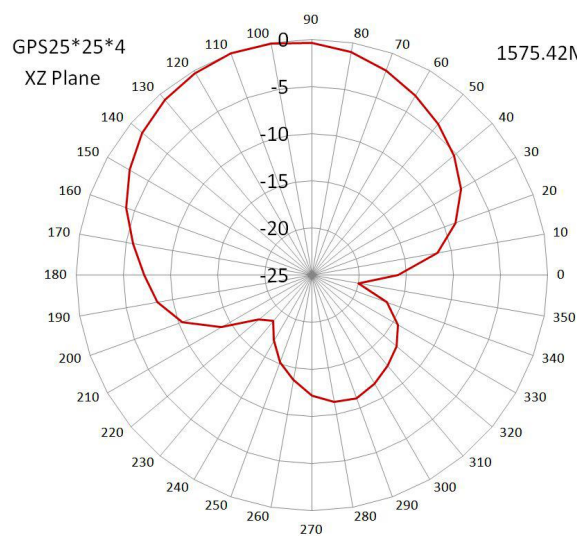
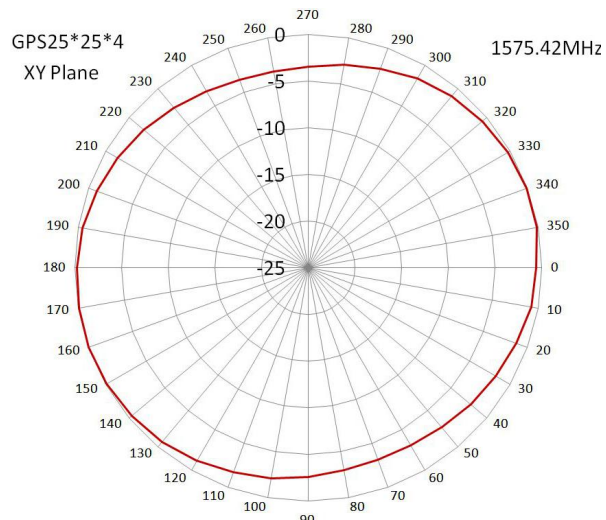

LTE Antenna

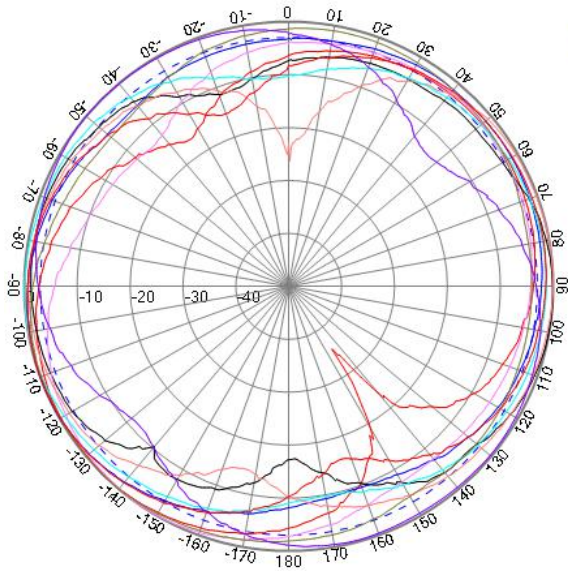

XY PLANE

- 测试频率: 700
- 测试频率: 824
- 测试频率: 868
- 测试频率: 960
- 测试频率: 1710
- 测试频率: 1850
- 测试频率: 1990
- 测试频率: 2170
- 测试频率: 2690

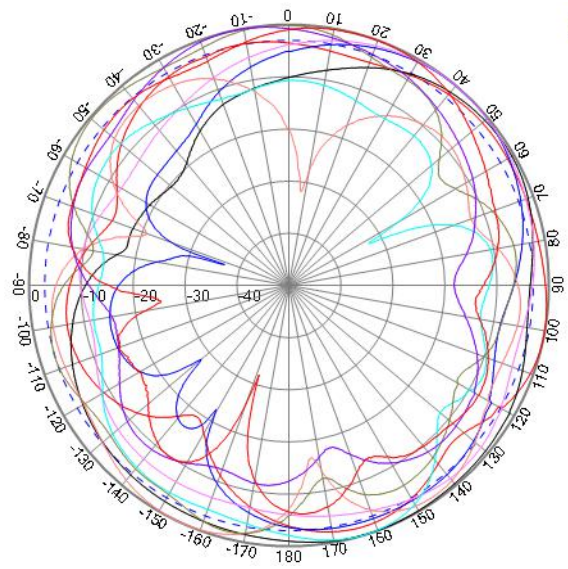

XZ PLANE

- 测试频率: 700
- 测试频率: 824
- 测试频率: 868
- 测试频率: 960
- 测试频率: 1710
- 测试频率: 1850
- 测试频率: 1990
- 测试频率: 2170
- 测试频率: 2690

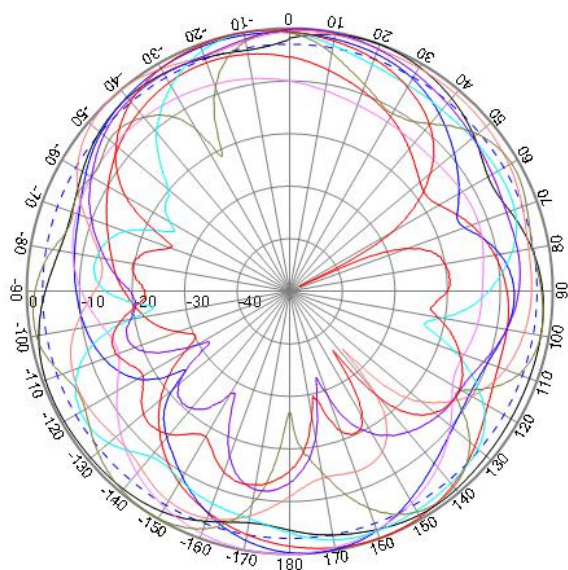

YZ PLANE

- 测试频率: 700
- 测试频率: 824
- 测试频率: 868
- 测试频率: 960
- 测试频率: 1710
- 测试频率: 1850
- 测试频率: 1990
- 测试频率: 2170
- 测试频率: 2690

JIAXING JINCHANG ELECTRONIC TECHNOLOGY CO.,LTD

Add: 398#, Zhenye Road, South Street, Jiaxing, Zhejiang, China

Http:// www.jinchanggps.com

E-mail: jcgps@vip.163.com

Tel: 86-0573-83692157/83692605/83958637 Fax: 86-0573-83958635

WIFI Antenna

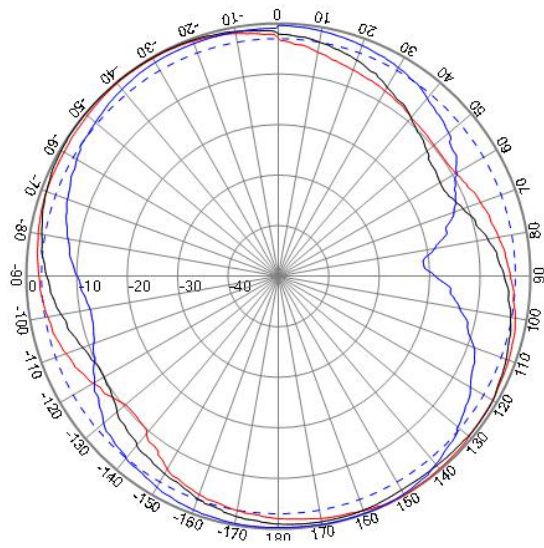

XY PLANE

测试频率: 2400

测试频率: 2450

测试频率: 2483

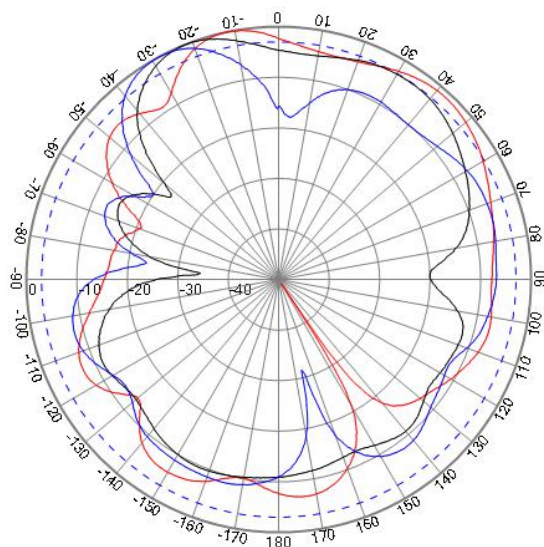

YZ PLANE

测试频率: 2400

测试频率: 2450

测试频率: 2483

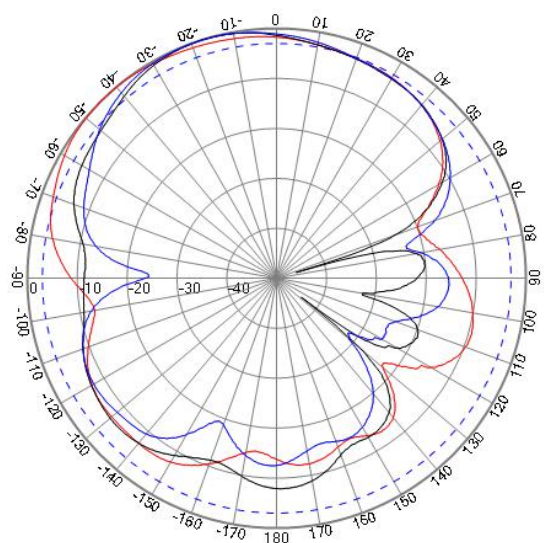

XZ PLANE

测试频率: 2400

测试频率: 2450

测试频率: 2483

JIAXING JINCHANG ELECTRONIC TECHNOLOGY CO.,LTD

Add: 398#, Zhenye Road, South Street, Jiaxing, Zhejiang, China

Http:// www.jinchanggps.com

E-mail: jcgps@vip.163.com

Tel: 86-0573-83692157/83692605/83958637 Fax: 86-0573-83958635