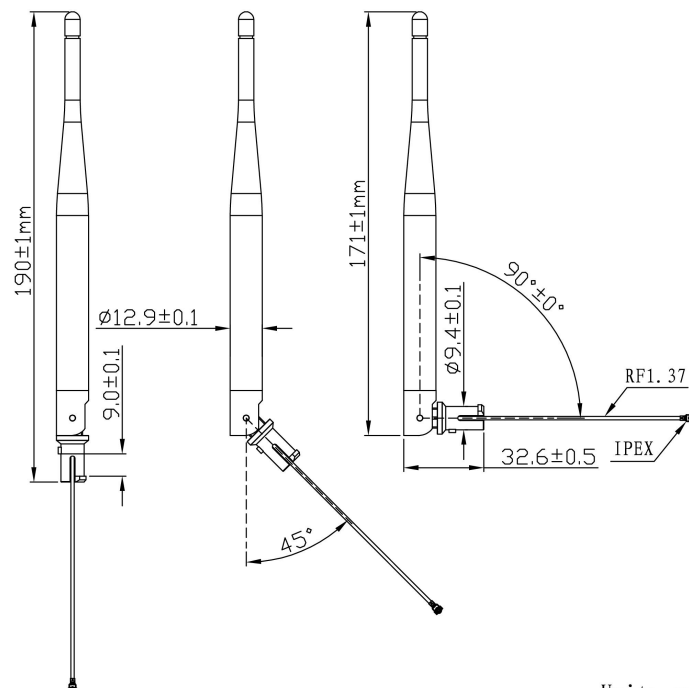

868MHz Antenna

JCG410-1**DIMENSIONS**

Unit: mm

JIAXING JINCHANG ELECTRONIC TECHNOLOGY CO.,LTD

Add: 398#, Zhenye Road, South Street, Jiaxing, Zhejiang, China

Http:// www.jinchanggps.com

E-mail: jcgps@vip.163.com

Tel: 86-0573-83692157/83692605/83958637 Fax: 86-0573-83958635

SPECIFICATIONS

Item	Specifications	
Antenna	Center Frequency	868MHz
	Band Width	CF \pm 8MHz
	Polarization	Linear
	Gain	3dBi
	V.S.W.R	<2.0
	Impedance	50 Ω
Mechanical	Cable	RG178/RF1.37 or others
	Connector	IPEX or others
	Mounting Method	Knuckle
Environmental	Operating Temperature	-40 $^{\circ}$ C~+85 $^{\circ}$ C
	Vibration	10 to 55Hz with 1.5mm amplitude 2hours
	Environmentally Friendly	ROHS Compliant

Radiation Pattern

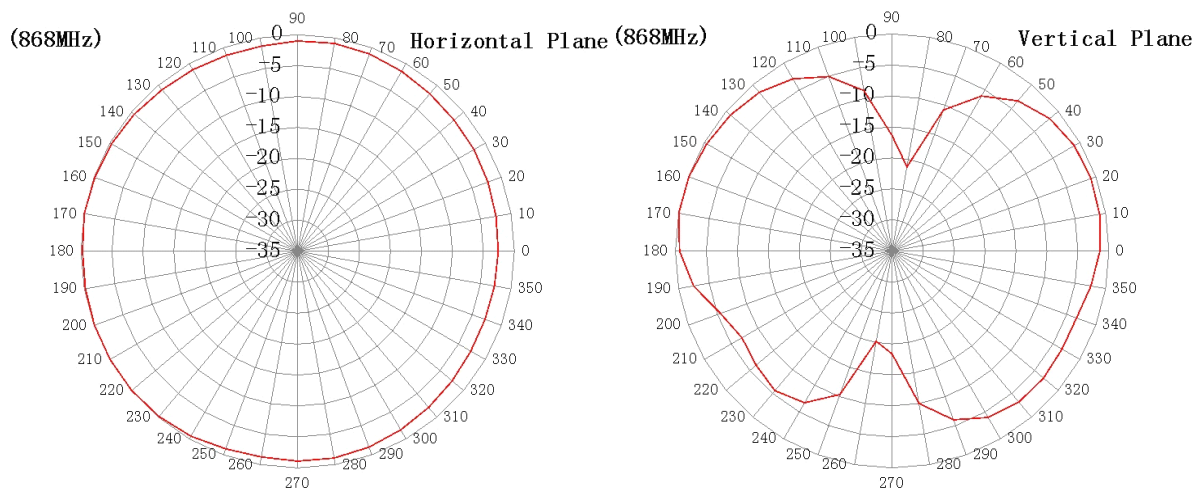

JIAXING JINCHANG ELECTRONIC TECHNOLOGY CO.,LTD

Add: 398#, Zhenye Road, South Street, Jiaxing, Zhejiang, China

Http:// www.jinchanggps.com

E-mail: jcgps@vip.163.com

Tel: 86-0573-83692157/83692605/83958637 Fax: 86-0573-83958635